

UT-IG - Tech. Report # 78

596

TR 28

Technical Report #4
10 November 1983

Pueblo Viejo-Quixal Seismograph Network
7 May 1983 through 12 September 1983

Submitted to: Ing. Rudolfo Morales Juarez
Instituto Nacional de Electrificación
6A. Ave. 2-73, Zona 4
Guatemala City, Guatemala

Prepared by: Dr. Tosimatu Matumoto
Institute for Geophysics
University of Texas at Austin
4920 North I.H. 35
Austin, TX 78751

Summer Parrish
Geological Sciences
University of Texas at Austin
Austin, TX 78712

Table of Contents

1. Introduction 1

2. Summary of Previous Work 1
 Fig. 2A Regional Seismicity
 Fig. 2B Composite Fault Plane Solutions
 of the events near the dam site
 Fig. 2C Distribution of earthquakes in
 the vicinity of Pueblo Viejo Dam
 27 Jan. 83 - 6 May 83

3. Operation of the Network 2

4. Epicenter Determination - 6 May 83 - 12 Sept. 83 3
 Fig. 4A Distribution of earthquakes in the
 vicinity of Pueblo Viejo Dam
 7 May 83 - 12 Sept. 83
 Fig. 4B Seismogram of Water-induced Earthquakes

5. Water-induced Earthquakes 4
 Fig. 5A Histogram Number Vs. S-P time (station 7)
 Fig. 5B Change of water level and water-induced
 earthquakes
 Fig. 5C Mohr Circle and Fracture Criterion Curve

6. Seismic Activity along Cuilco-Chixoy-Polochic Fault 5
 Fig. 6A Frequency Vs. Magnitude
 Fig. 6B Fault Plane Solutions of the earthquakes
 along Cuilco-Chixoy-Polochic Fault
 Fig. 6C Movement of Cuilco-Chixoy-Polochic Fault

7. Recommendation 6

Table 1

Attachment

1. Introduction

This report will review the results of the INDE/UT seismic monitoring program during the period from 7 May 1983 through 12 September 1983. During this period, the water level in the Pueblo Viejo reservoir rose from 762 m to 795 m. Water-induced earthquakes started to take place from June 16. As of September 12, 14 water-induced earthquakes were registered and located in proximity to the reservoir.

Due to the delay of payment to the University of Texas from INDE, the account for this program was suspended since March, 1983. Our activity, including data analysis and maintenance of the network was significantly hindered by the financial situation. We expect, however, that the crippled network operation will be normalized in the near future as the financial situation improves.

2. Summary of Previous Work

In the preceding reports, the regional and local seismic activities were summarized as follows:

- A. Two Major fault systems, the Motagua fault and Cuilco-Chixoy-Polochic fault, proved to be active; they comprise a complex plate boundary between the North American and the Caribbean plates. Due to the nature of the plate boundary, potential for major earthquakes (magnitudes up to 7.5), exist along these faults.
- B. A prominent northwest-southeast trending seismic lineation which passes through the vicinity of the dam site started to emerge during the study period of 11 March 1981 through 16 April 1982 (Figure 2A). This trend was not observed during the preceding period.
- C. The composite fault plane solutions of the earthquakes in the area of Pueblo Viejo dam site are given as follows (Figure 2B):

Fault Plane #1	Strike N17°W	Dip 30°E
Fault Plane #2	Strike N48°E	Dip 35°NW

These solutions are approximately in agreement with the stress field consisting of north-south compression and east-west tension. Such a stress is interpreted as the consequence of the regional plate motions; namely, northward thrust of Cocos plate and westward movement of the Caribbean plate, or differential shear between the CCP fault and the Motagua fault.

- D. Since the impounding of the reservoir started, a marked increase in the level of local seismic activity was observed. The earthquake count during the period from 27 January 1983 through 6 May 1983, along the Cuilco-Chixoy-Polochic fault nearly doubled as compared to the count of the pre-loading period. None of the earthquakes, however, were located in the immediate vicinity of the reservoir during this period (Figure 2C).

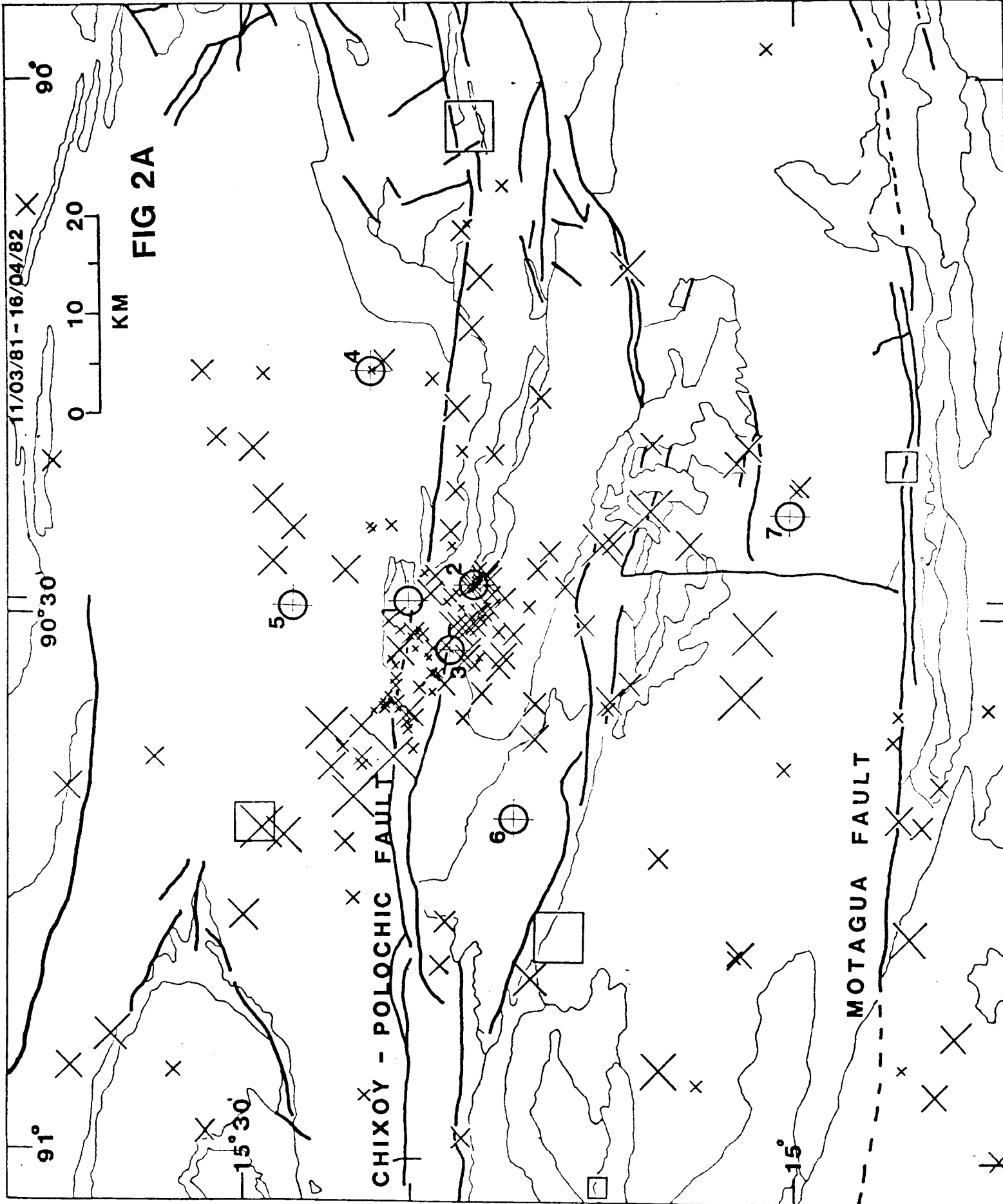

11/03/81 - 16/04/82

FIG 2A

KM

CHIXOY - POLOCHIC FAULT

MOTAGUA FAULT

91°

90°30'

90°

15°30'

15°



4

5

3

2

6

7

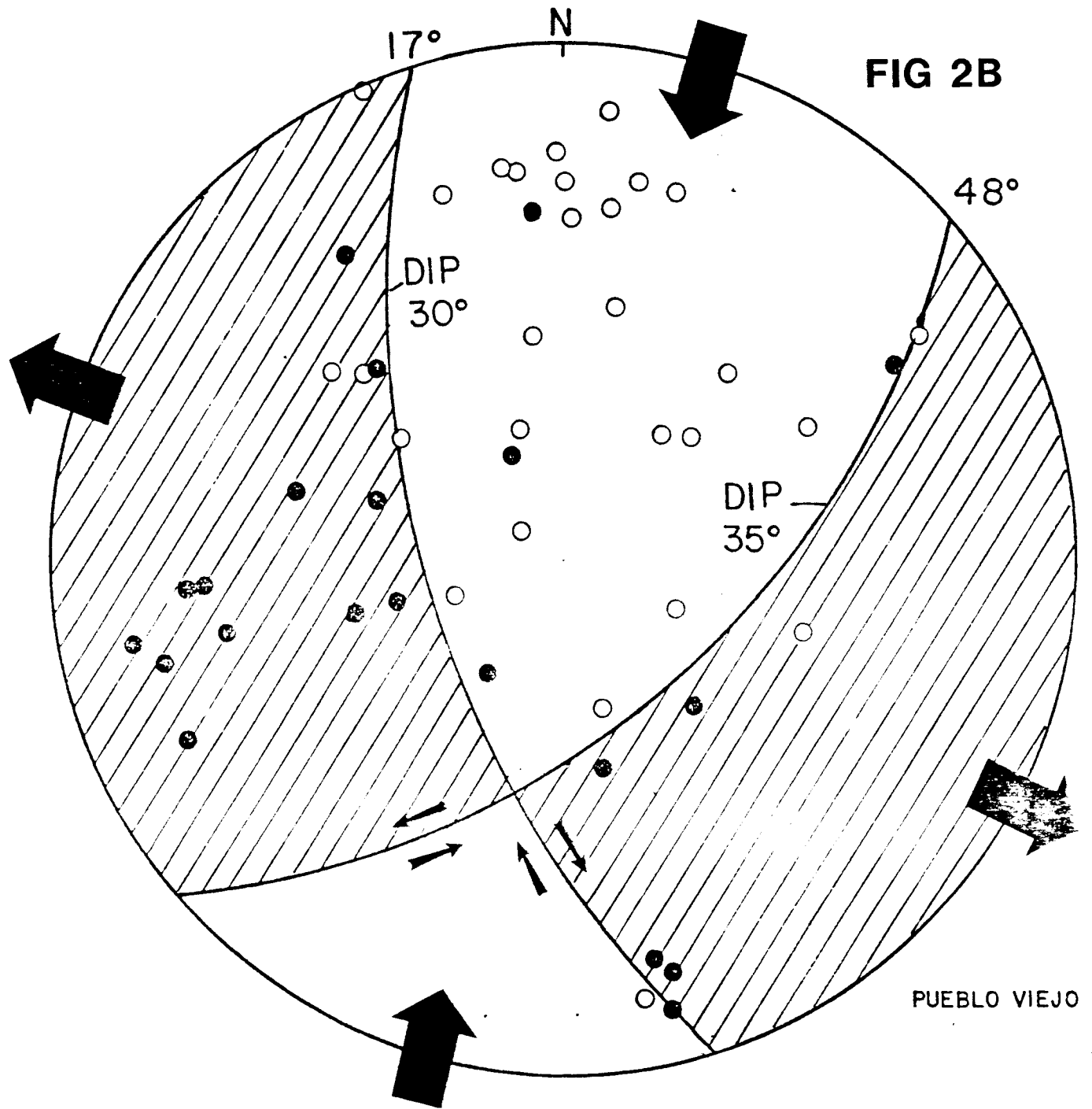

Figure 2B. Composite fault plane solution for the events in the vicinity of Pueblo Viejo Dam.

4. Epicenter Determination, 7 May 1983-12 September 1983

Seismic data (including both Drum and COSMOS) recorded during the period from 7 May 1983 through 12 September 1983 was analyzed and utilized in this report. Due to its applicability to a research interest, this analysis concentrated on earthquakes within an 80 km radius of the center of the network.

To assure the compatibility of the analysed data with the earthquake data file from U.S. Geological Survey, the epicenter program was switched from our traditional GREPC1 to HYPO71 (Lee and Lahr, 1975). The located coordinates given by both programs agree well within the error limit.

The origin time, latitude, longitude, depth, magnitude, root mean square error, error in horizontal and vertical direction are listed in Table 1. Of earthquakes listed in Table 1, those with large error were discarded and only the events which were accurately located (RMS < 1.0) are plotted in Figure 4A.

Comparison of the epicenter plots shown in Figure 2C (27 January 1983 - 6 May 1983) and those from the current period (Figure 4A: 7 May 1983 - 12 September 1983) reveals significant contrast in the distribution of the earthquakes, especially near the reservoir.

During the first 5 months of 1983 (Figure 2C), the vicinity of the reservoir was characterized by a gap in events. During the following four month period from 7 May 1983 - 12 September 1983, however, 14 water-induced earthquakes were located along the reservoir. Another significant difference between these two figures was a marked increase of seismic activity along the Cuilco-Chixoy-Polochic fault system. As many as 22 events were located along the CCP fault in Figure 4A as compared to only 10 events situated along the fault in Figure 2C.

Some typical seismograms of water-induced earthquakes were selected and illustrated in Figure 4B. Characteristic seismic signatures for water-induced earthquakes are as follows:

- a) Short S-P time interval recorded by stations 1-3 and 6-7. Normally the S-P times registered at these stations are less than 2.0 seconds. The S-P time recorded at station 7 provides the most valuable insight.
- b) Large amplitude variation among the stations. Since the near-field amplitude attenuates rapidly as distance increases, the amplitudes registered at each station vary significantly. The majority of water-induced earthquakes were recorded only by stations 7 and/or 6.
- c) The arrival times to stations 4 and 5 are usually 1 - 2 seconds behind those of stations 1, 2, and 3, and the arrival time to station 1 is lagging from those of stations 2 and 3 by 1 - 2 seconds.

Observation of such evidence facilitates identification of probable water-induced events even before epicenter determinations.

FIG 4A

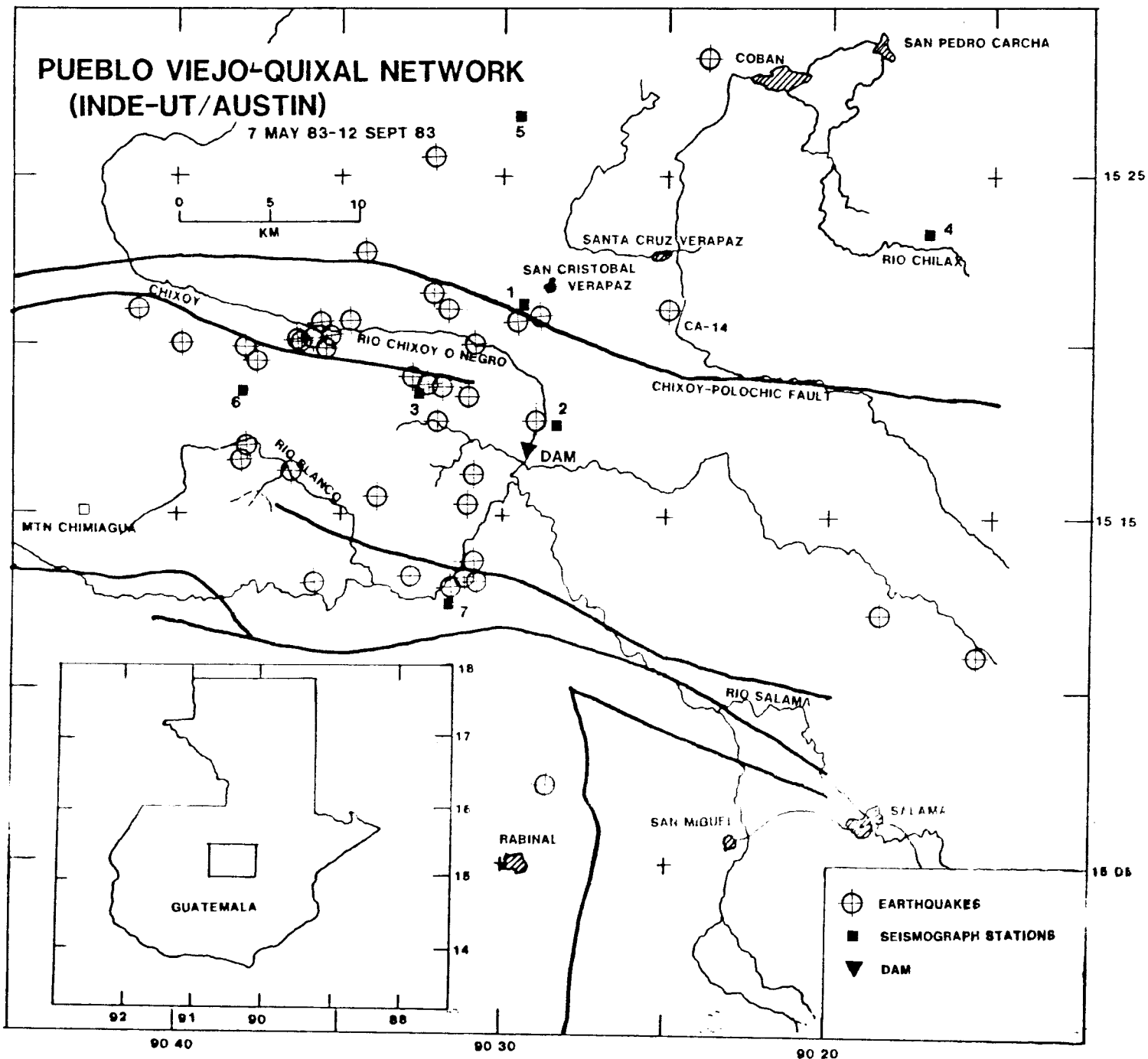

WATER INDUCED EARTHQUAKE

ST 7

YR MO DAY
ON 1983 8 /6
OFF 1983 8 /8

SEC

STATION
REC BAND

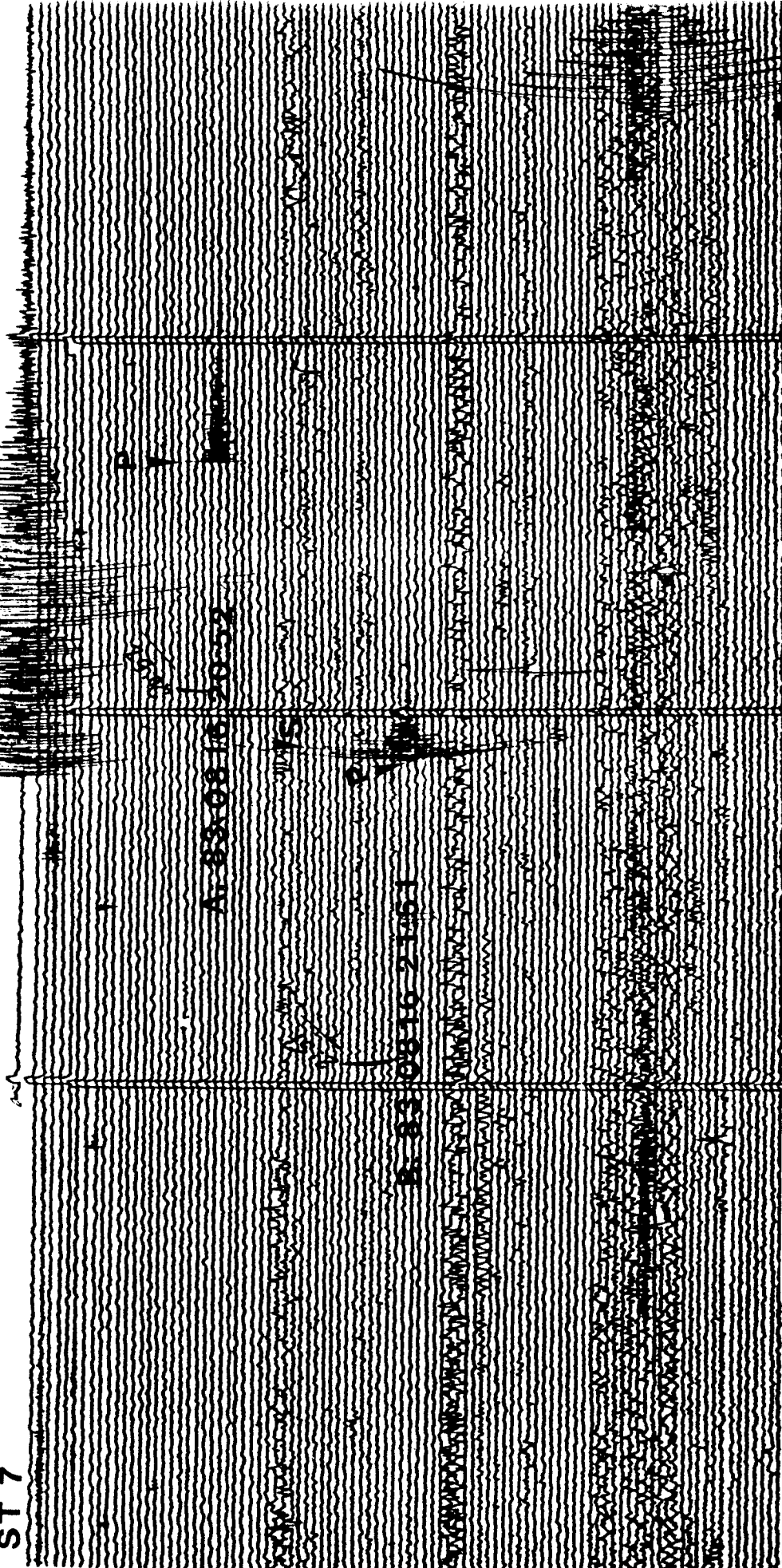

Figure 4B Seismogram of water induced earthquakes. There are two water induced earthquakes recorded in this chart:
A: 83 0816 20:52 and B: 83 0816 21:51
The event B is recorded at St 7 only, due to the fact that the event is located close to St 7. See the amplitude at St 7 is very large but the amplitudes at other stations became too small to be recorded.

PUEBLO VIEJO, GUATEMALA

STATION 6 CAMP Z

07/01/83 TIME CORR SEC

YR MO D/

ON 1983 8 /

OFF 1983 8 /

ST 6

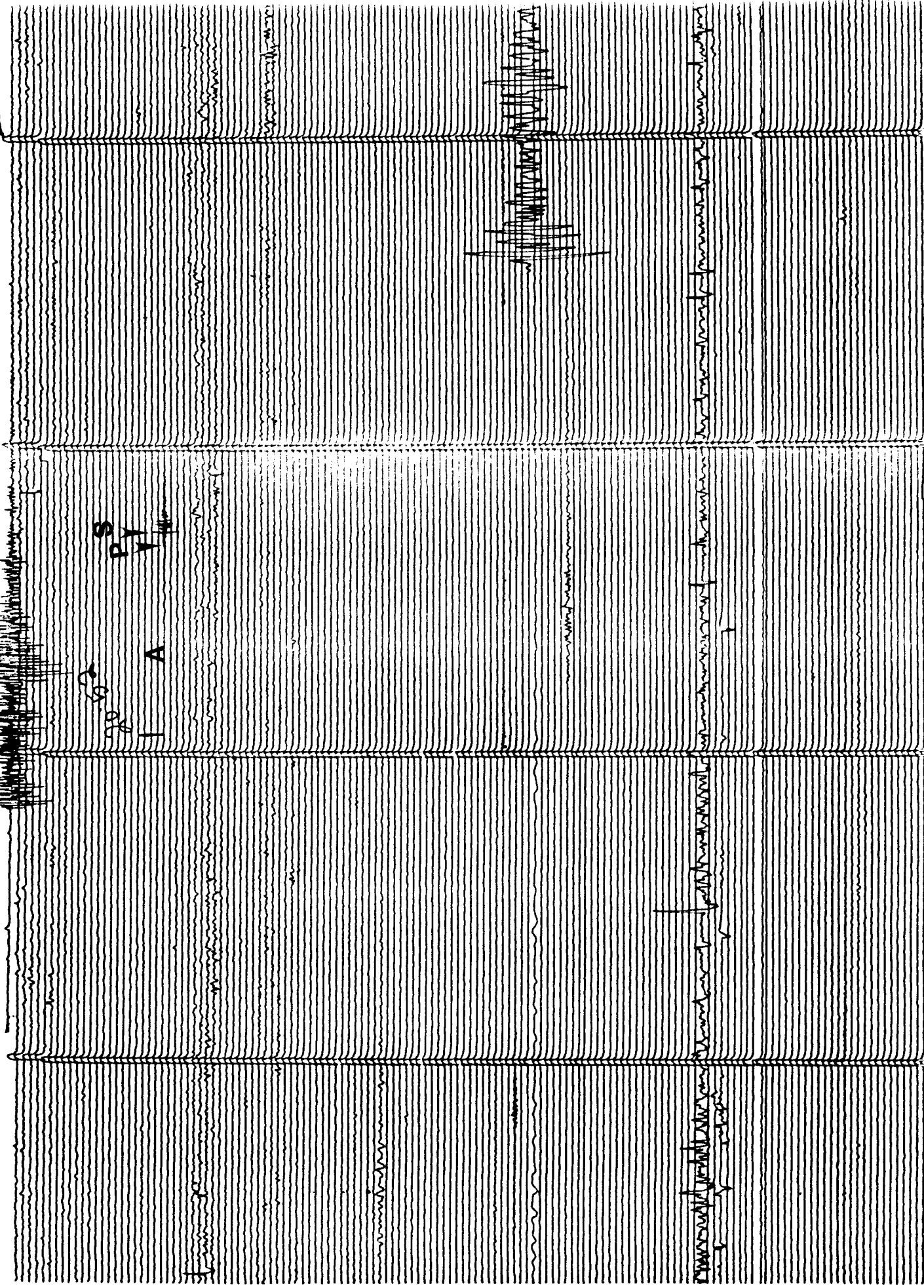

YR MO
1983 8

01 19 83 8

STATION 5
RECORDING 1.50
TIME CORR

ST 5

ST 5

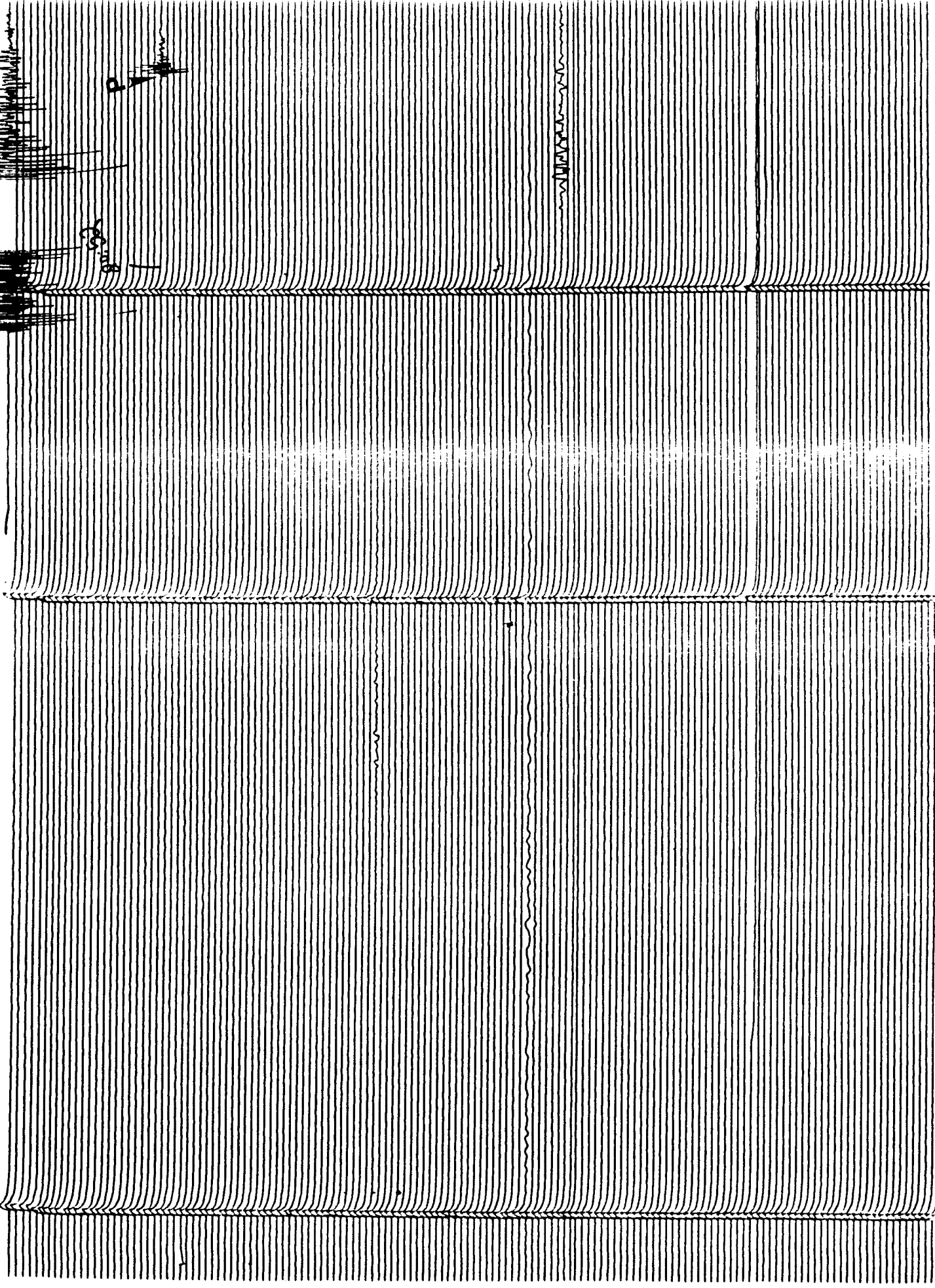

PUEBLO-VIEJO, GUATEMALA

STATION Z COMP Z

REC GAIN .025 TIME CORR

ST 2

YR ON 1983

MO 8

DAY 18

SEC

OFF 1983

8

20.52

(A

PS

AY

2.61

(

5. Water-Induced Earthquakes

To illustrate the change of the distribution of earthquakes, the histogram showing the number of earthquakes vs. S-P time interval was plotted in Figure 5A. Two separate time intervals: (1) from 13 February 1979 through 28 April 1979 and (2) from 7 May through 12 September 1983 were chosen. The former represents the pre-loading period and the latter is the second half of the loading period.

Station 7 was chosen because it is the closest station to the reservoir. Unfortunately station 7 was relocated between these two time periods, but the former was located only 3 km west of the latter and such a minute change does not significantly alter the general pattern of the histogram.

In the lower frame, which illustrates the histogram from 13 February 1979 - 28 April 1979, only 20 percent of the events (7 out of 35 events) were distributed within the S-P time interval shorter than 2.0 seconds. In the upper frame (7 March 1983 - 12 September 1983) 62 percent of the events (37 out of 60) were distributed within the S-P time interval shorter than 2.0 seconds. The peak distribution appearing between 0.5 and 1.5 seconds in the upper frame is apparently due to the distribution of water-induced earthquakes that emerged since 19 June 1983.

The upper and lower frame of Figure 5B correlate the water level of the reservoir and recorded earthquakes, respectively. The earthquakes in the lower frame were plotted in two different symbols. Those occurring within a 32 km radius are shown by closed circles and those within a 16 km radius are indicated by open circles. Earthquakes located in the immediate vicinity of the reservoir were illustrated by an asterisk with an open circle.

It is noteworthy that the water-induced earthquakes located in the vicinity of the reservoir was first recognized on June 19, 1983 (Table 1). These events occurred during the prolonged period of constant water level at 769 m. The beginning of water-induced earthquakes during this stable elevation provides a clue to examine the mechanism of water induced earthquakes.

The shear strength τ is determined by the effective stress $\sigma_e = \sigma_n - P$ as follows:

$$\tau = \tau_0 + \mu(\sigma_n - P)$$

where τ_0 is the cohesive shear strength, μ the coefficient of internal friction, σ_n the normal stress across the incipient fracture plane, and P the pore pressure.

A Mohr diagram in which shear stresses τ are plotted versus principal effective stress σ_e is drawn in Figure 5C for strike-slip faulting and normal faulting. The failure occurs when Mohr's circle becomes tangential to the Navier-Coulomb failure criterion curve. The orientation of principal stresses associated with the mode of faulting are indicated to the right-hand frame of Figure 5C.

FIG 5A

(2) 7 MAR 83-12 SEP 83

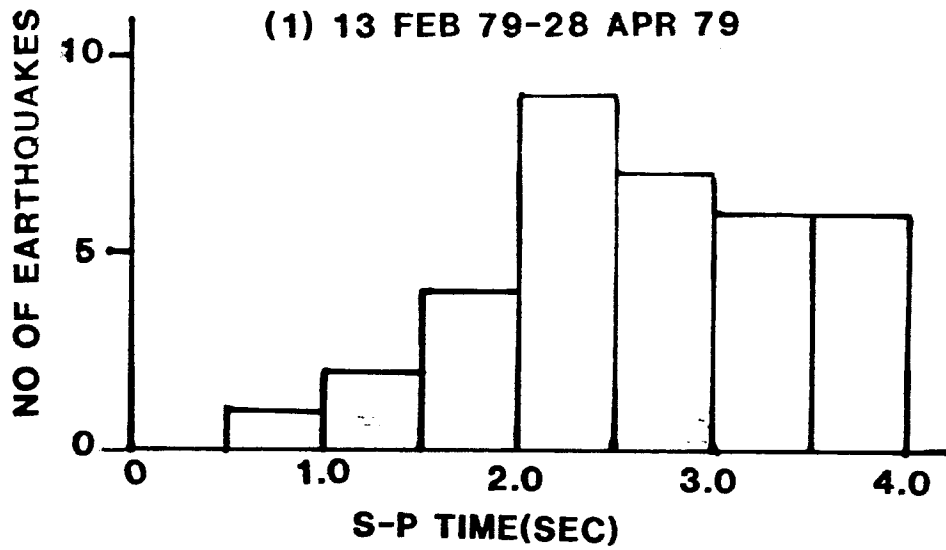
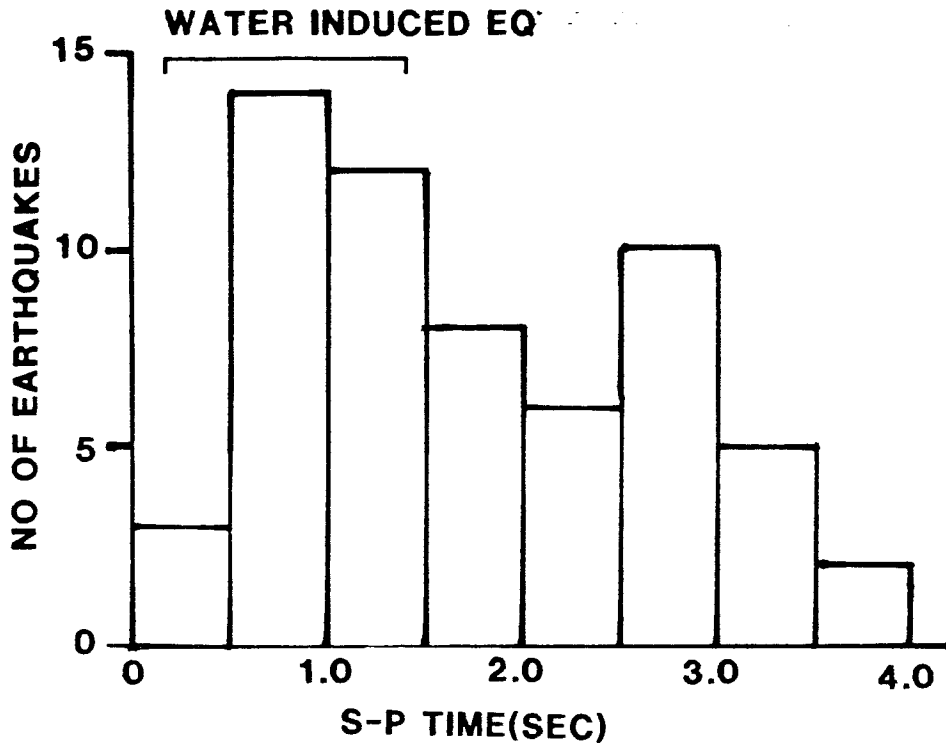
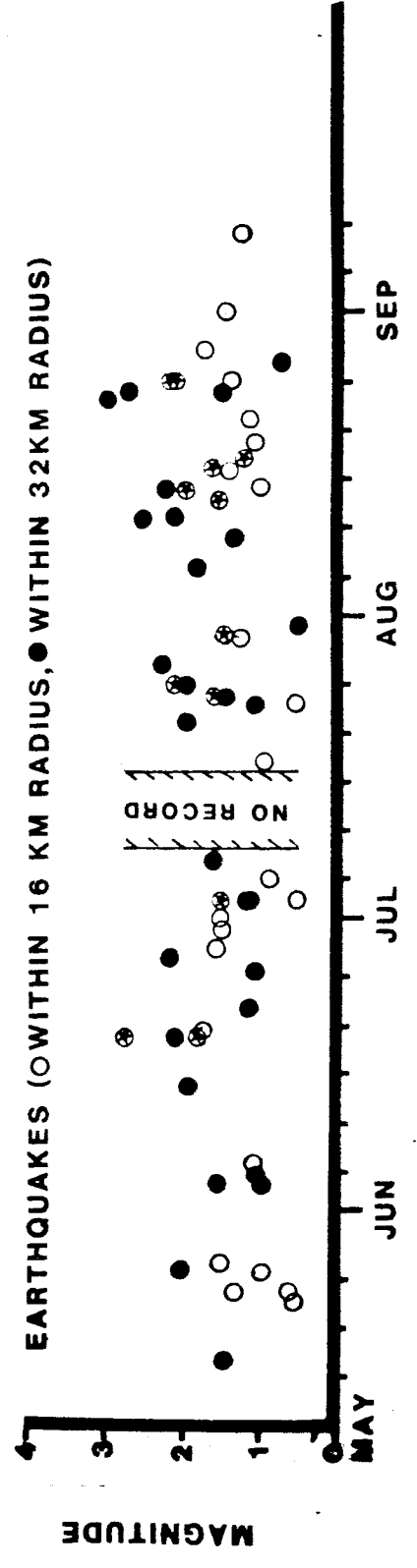
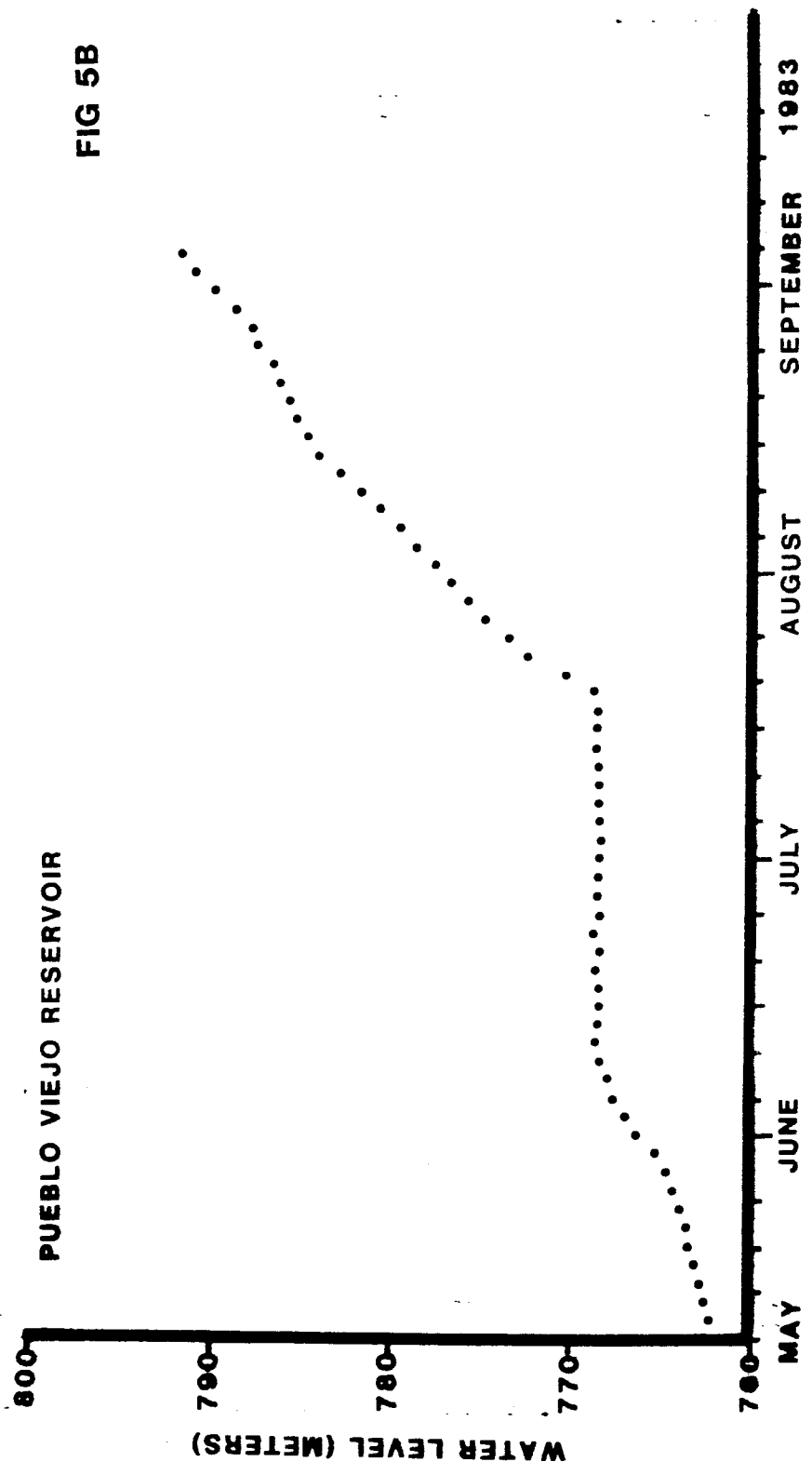
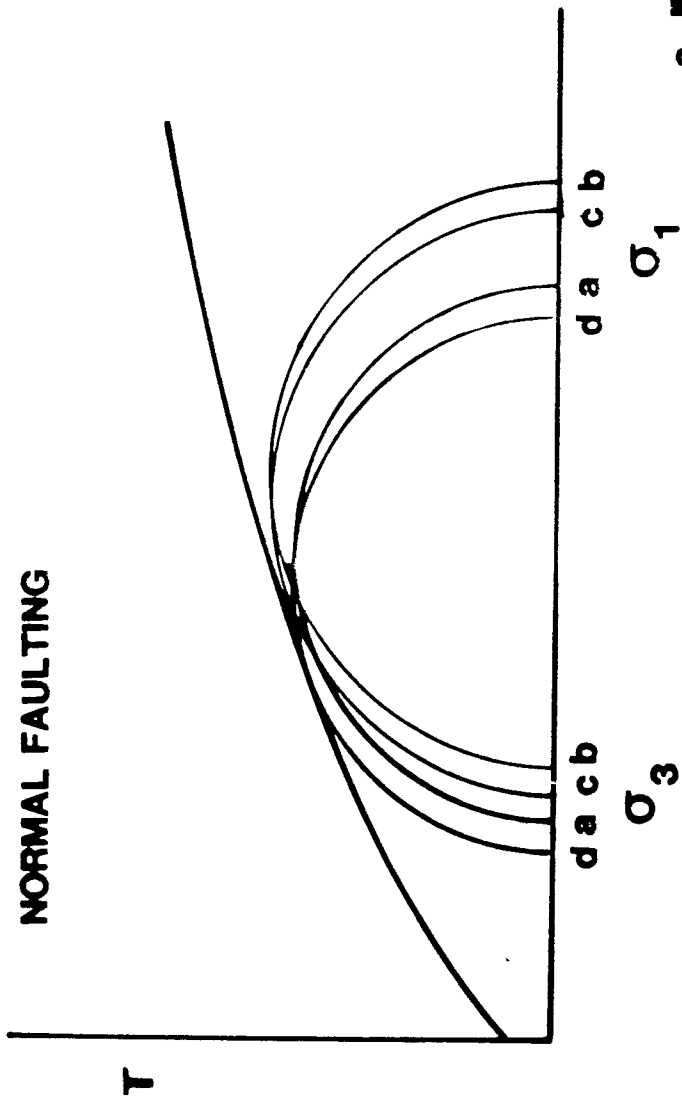

FIG 5B



NORMAL FAULTING



STRIKE-SLIP FAULTING

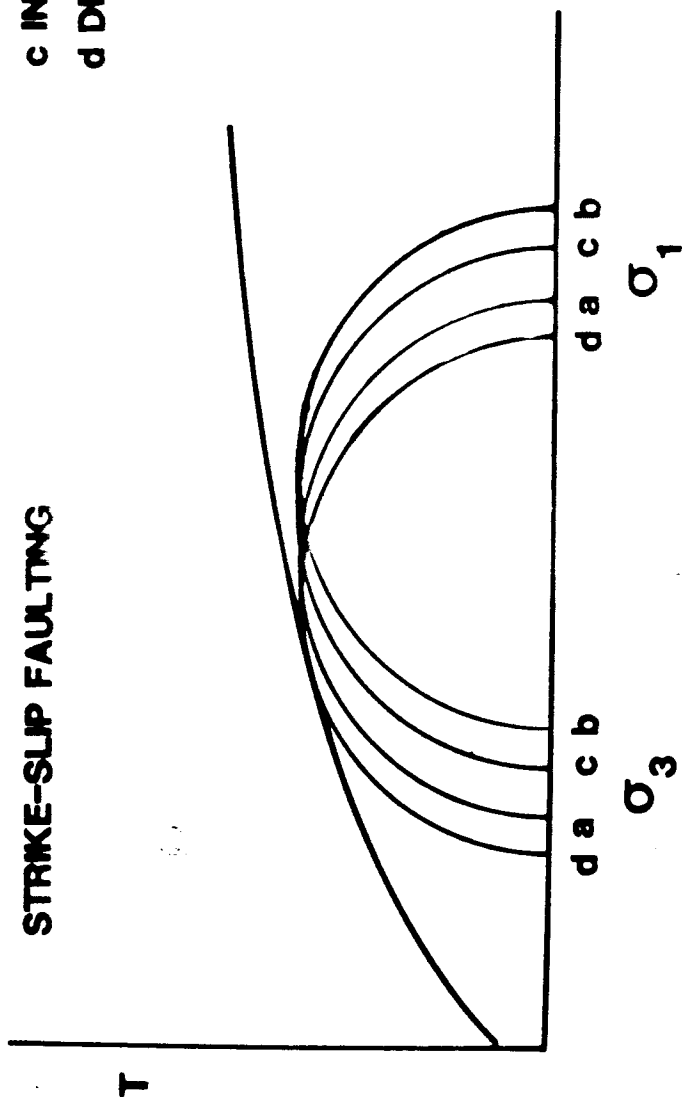
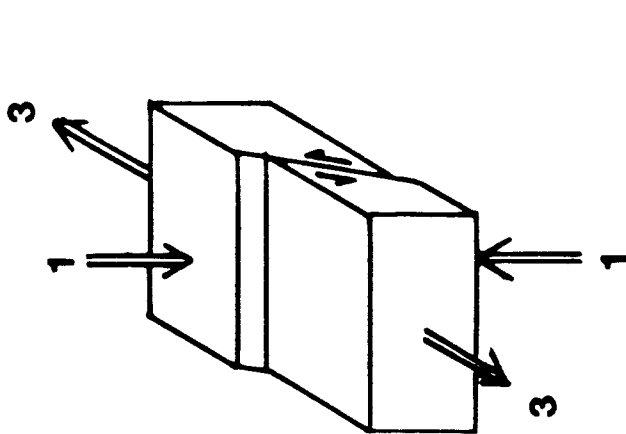
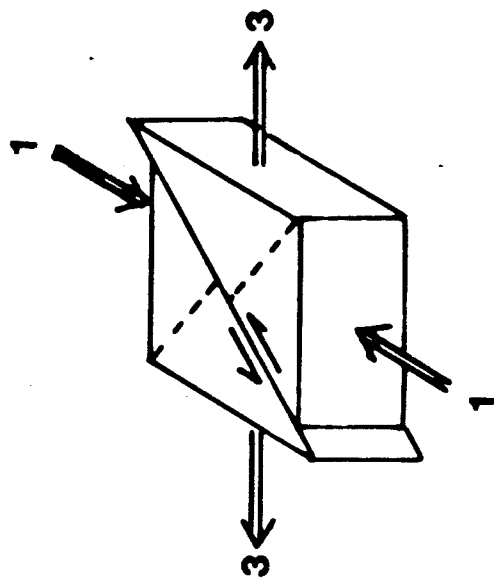

FIG 5C



- a INITIAL
- b INCREASE OF NORMAL STRESS
- c INCREASE OF PORE PRESSURE
- d DECREASE OF NORMAL STRESS



Scantness of data prohibits us from identifying the fault plane solutions of water-induced earthquakes positively. But their fault plane solutions seem to be in general agreement with those shown in Figure 2B. This solution is akin to strike-slip but some element of normal to thrust faulting is present.

As the water level increases, both the normal stress σ_n and the pore pressure P increases. Figure 5C shows the Mohr's circles for four different circumstances. The circle a-a represents the initial stage, and moves to b-b after the increase of water level. Increased pore pressure moves the Mohr's circle to c-c but pore pressure P propagates gradually by diffusion and this change occurs with some time lag.

If the level of reservoir water remains at a constant elevation, the Mohr circle never becomes tangential with the fracture criterion curve for strike-slip environment, but under normal to thrust environment, the Mohr circle may become tangential with the fracture curve due to expanded radius of the Mohr circle.

If a fast draw-down of reservoir water moves the Mohr circle from c-c to d-d, fracture occurs under strike-slip environment as well as normal to thrust type environment.

Due to the presence of a major strike-slip fault system nearby, it is worthwhile to seriously consider avoiding rapid draw-downs from the Pueblo Chixoy reservoir.

6. Increase of the Activity Along the Cuilco-Chixoy-Polochic Fault

In the previous report (Technical Report #3, 10 June 1983), the relations between the number of earthquakes (N) versus magnitude (M) were examined for four different cases as listed below:

$$\log N = 1.89 - 0.46 M \text{ (within 32 km radius, 12 Feb.-12 May 1983)} \quad (1)$$

$$\log N = 1.69 - 0.46 M \text{ (within 32 km radius, 12 Feb.-12 May 1982)} \quad (2)$$

$$\log N = 1.65 - 0.59 M \text{ (within 16 km radius, 12 Feb.-12 May 1983)} \quad (3)$$

$$\log N = 1.38 - 0.49 M \text{ (within 16 km radius, 12 Feb.-12 May 1982)} \quad (4)$$

To compare the level of seismic activity during the second half of loading, a similar relation was studied for the period from 13 May - 12 September 1983 (Figure 6A) and is listed as follows:

$$\log N = 2.34 - 0.63 M \text{ (within 32 km radius, 13 May-12 Sept. 1983)} \quad (5)$$

Normalizing the number of earthquakes for the three month period as given in the equations (1)-(4), is as follows:

$$\log N = 2.21 - 0.63 M \text{ (same as equation (5), normalized to 3 month period)} \quad (6)$$

The slope (b-value) of the number-magnitude relation for equation (6) is greater than any of the previous equations. This means that the increase of smaller events is more significant than those of larger events.

FIG 6A

Within 32KM Radius

⊕ 1983 (May 13-Sep 12)

○ 1983 (Feb 12-May 12)

□ 1982 (Feb 12-May 12)

Within 16KM Radius

● 1983 (Feb 12-May 12)

■ 1982 (Feb 12-May 12)

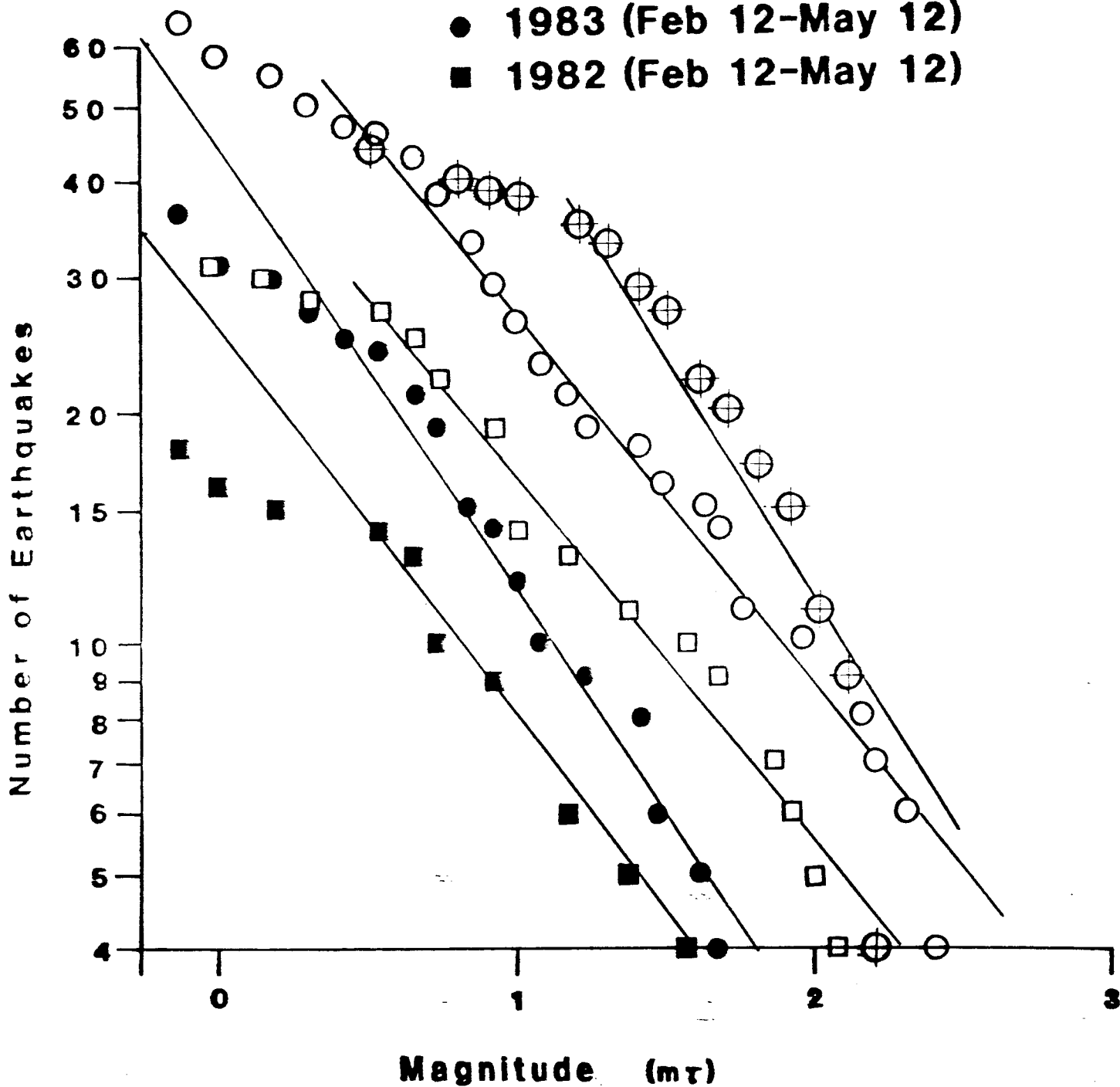

FIG 6B

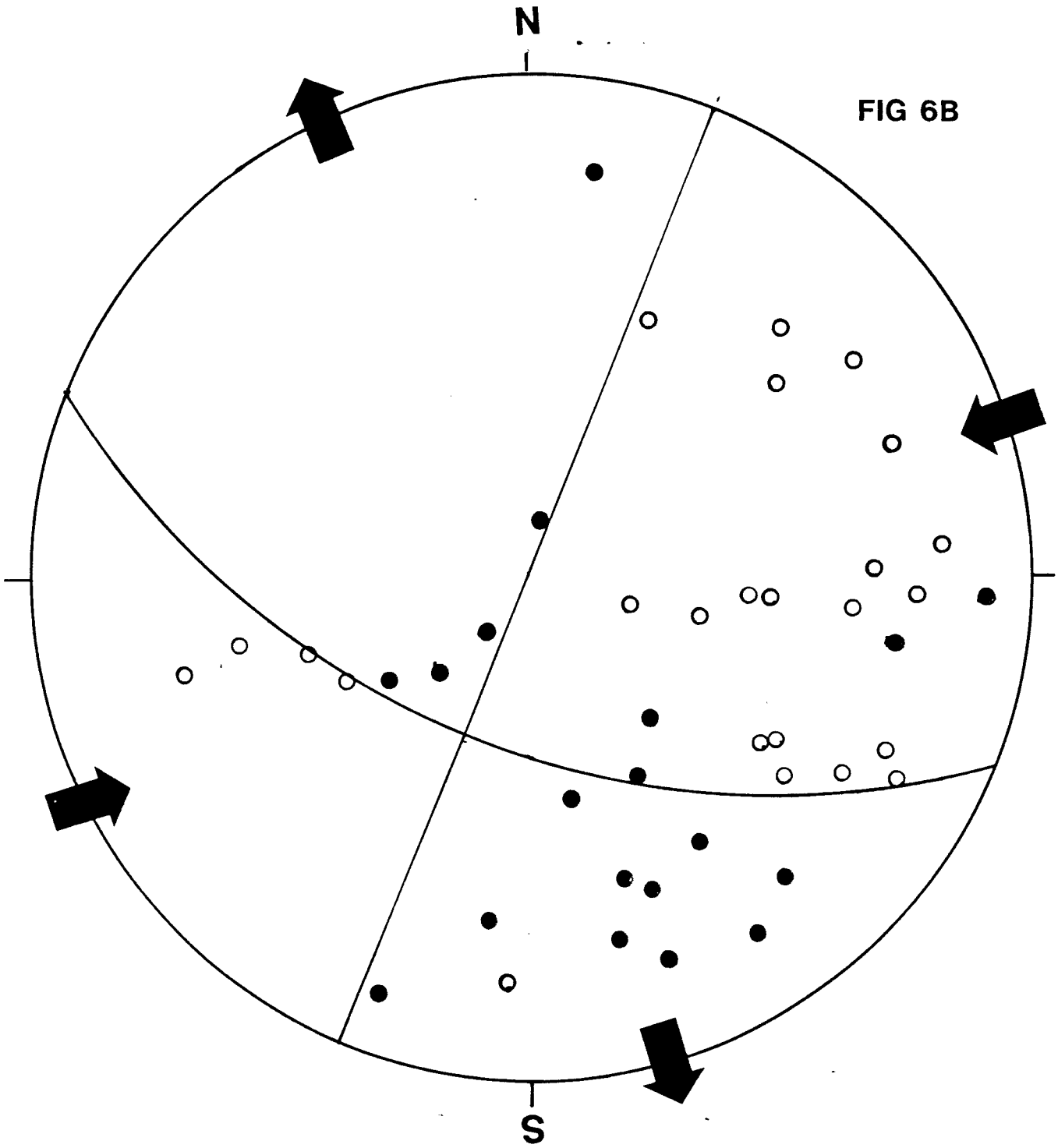
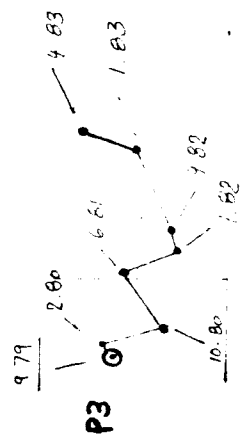
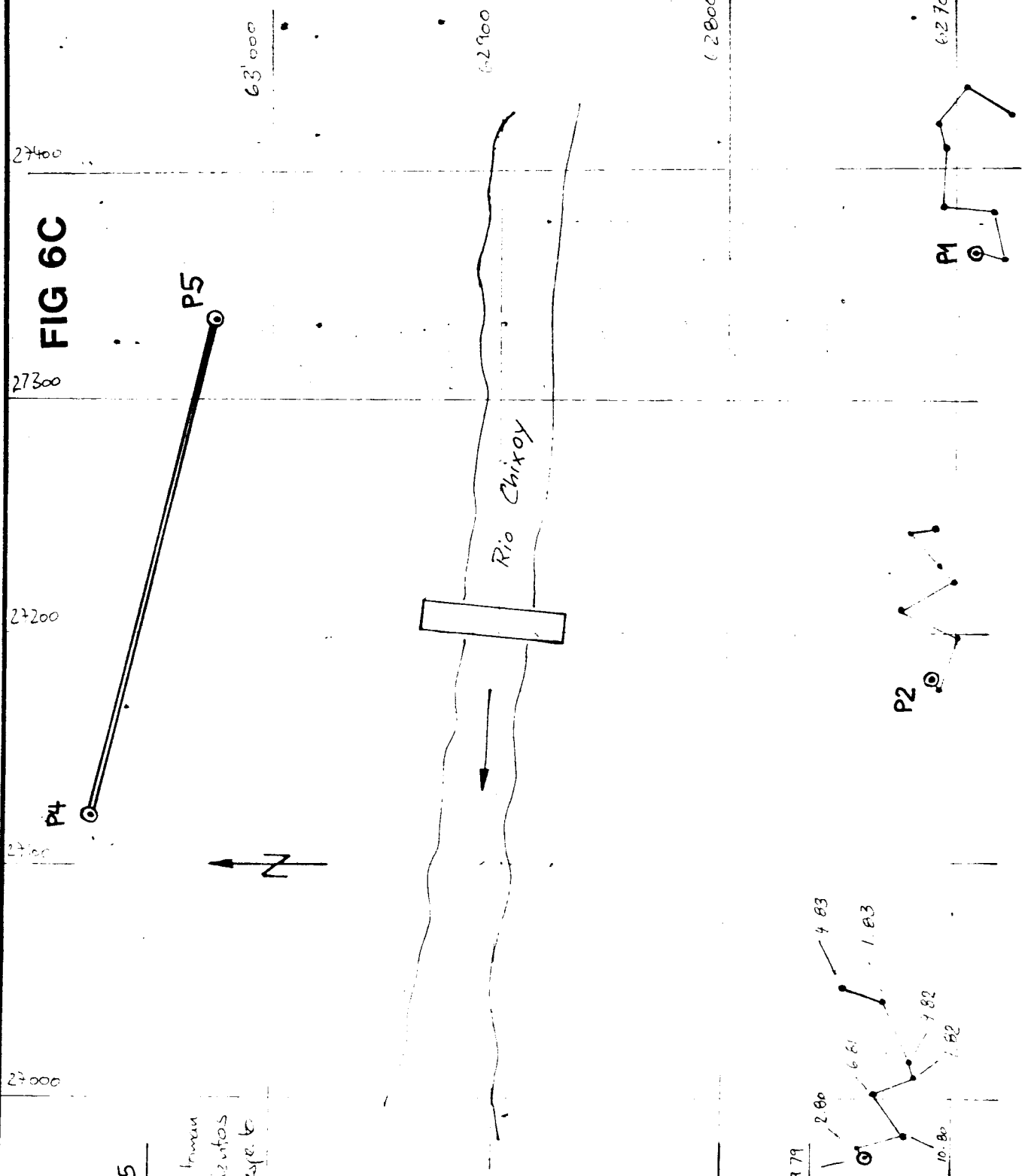

FIG 6C

**AGUA BLANCA
SISTEMA DE PILARES P1-P5**

Suposición: Los pilares P4, P5 se tienen como fijos. Se calculan movimientos RELATIVOS del lado sur con respecto al lado norte.

ESC. 1:1



For instance, the numbers derived from equation (6) as compared to those from equation (1) are:

2.8 times at $M = 0$
1.32 times at $M = 1$
but 0.90 times at $M = 2$

The composite fault plane solutions for the events distributed along the Cuilco-Chixoy-Polochic fault were studied and shown in Figure 6B.

As contrasted to the fault plane solutions for earthquakes located near the dam site (Figure 2B), one of the fault planes shown in Figure 6B is almost parallel to east-west trending CCP fault. It is not known whether an increase of pore pressure would trigger a major earthquake along CCP fault or not.

Sonsorio Lami generously provided important information on the movement of the CCP fault (Figure 6C). The triangulation of the bench marks across the fault has been carried out since September 1979. During the 44 month period, the average left-lateral movement of the bench marks were estimated at 0.73 cm/yr. Jordan (1975) indicated that the relative motion of the Caribbean-North American plates is at the rate of 2.2 cm/yr. Therefore, the movement of the CCP fault is taking up about 1/3 of the motion between the Caribbean and North American plates.

In general, most of the major events were preceded by a premonitory anomaly, such as crustal deformation, seismicity gap, and/or velocity changes. For an event of magnitude 7, for instance, such a premonitory phenomena may start at least several months prior to the impending event. It is highly recommended that the triangulation survey should be repeated on a monthly or bi-monthly interval so as to permit a detailed analysis of such a premonitory phenomenon.

7. Recommendation

- 7.1 Repair of Seismic System - As soon as the invoicing problem is resolved and the INDE account is released, the University of Texas will try to restore the entire seismic system to full capacity. It is requested that INDE install a line voltage monitoring recorder, preferably with a low-speed chart recorder, to assure the safety of the computerized system.
- 7.2 Use the automated epicenter determination only for the first reference. Any important events should be examined manually following the procedure in 7.3.
- 7.3 As described in section 4, a probable water-induced earthquake can be identified even without the computer printout and analyzed on a daily basis. It is recommended that a more accurate epicenter (in addition to automated epicenter determination) should be sought by inputting the eyeball readings manually into the computer to utilize the time sharing epicenter program featured in the NOVA 3/12 computer.

- 7.4 Triangulation survey of bench marks across the CCP fault should be repeated more frequently. Measurement at monthly or bi-monthly intervals is recommended.
- 7.5 Rapid draw-down from reservoir creates circumstances to trigger water-induced earthquakes for strike-slip environment. Due to the existence of Chixoy-Polochic fault, it is worthwhile to caution against rapid draw-down from the Pueblo Chixoy reservoir.

Reference

Lee, W. and S. Lahr, HYP071 (revised): A computer program for determining hypocenter, magnitude, and first motion pattern of local earthquakes, U.S.G.S. Open-File Report 75-311, 1975.

Jordan, T. H., The present-day motions of the Caribbean Plate. Jour. Geophy. Res., 1975, 80, 4433-4439.

Table 1 List of Earthquakes 7 MAY 83 - 12 SEP 83

N	DATE	ORIG.	TIME	LAT N	LON W	DEPTH	MAG.	RMS	ERH	ERZ
1	830515	1123	36.63	15.3893	90.3802	30.38	2.14	2.04	52.1	18.5
2	830516	1627	30.83	14.9568	90.2787	6.84	1.64	11.42	577.4	813.4
3	830517	326	29.44	15.6945	90.6310	3.65	1.44	2.61		
4	830522	2334	2.17	15.3220	90.3737	4.50	2.48	7.33	6.7	14.6
5	830523	305	5.05	15.2958	90.4767	2.50	0.54	3.50		
6	830524	44	23.22	15.3107	90.5357	2.50	1.31	0.16		
7	830524	1628	18.42	15.2472	90.4325	0.63	2.07	7.86	57.1	591.7
8	830526	320	40.99	15.3165	90.5415	13.99	1.96	0.25	3.4	1.7
9	830526	631	30.60	15.2650	90.5572	1.25	0.97	12.66	100.2	380.5
10	830527	1421	23.09	15.0527	90.8953	5.00	1.49	13.06	*****	*****
11	830604	855	7.22	15.3893	90.3962	5.00	0.99	5.85	117.3	145.0
12	830604	2335	8.50	15.4022	90.3262	1.25	1.58	4.65	55.1	794.7
13	830605	19	23.15	15.2138	90.5180	5.00	1.08	28.35	14.6	14.0
14	830605	1027	56.53	15.1907	90.1512	8.58	1.91	0.61	13.1	*****
15	830606	1321	40.90	15.3987	90.5180	5.00	1.09	25.12	168.7	206.8
16	830609	1933	58.53	15.1798	90.6335	4.50	0.58	4.30		
17	830611	124	27.75	15.4347	90.5485	0.31	0.59	18.33		
18	830614	2040	12.05	15.2547	90.2787	10.20	1.91	2.55	22.4	58.5
19	830615	433	38.28	15.4760	90.3952	7.22	2.17	0.42	2.8	1.3
20	830619	544	23.47	15.3760	90.5705	16.63	2.08	0.51	3.9	3.2
*21	830619	2219	7.42	15.2663	90.5180	14.88	1.78	0.93	5.9	5.7
*22	830619	2219	26.49	15.2138	90.5985	5.00	2.73	0.77	7.3	13.2
23	830620	2053	18.00	15.1727	90.4772	2.50	1.78	0.30	2.1	3.6
24	830622	511	24.13	15.3548	90.5953	2.50	1.17	7.15	39.5	106.8
25	830626	1850	18.74	15.3408	90.6662	10.42	1.09	0.46	5.0	3.6
*26	830627	841	17.20	15.2852	90.6335	11.20	2.15	0.49	4.4	4.2
27	830628	549	44.17	15.3375	90.5167	10.77	1.67	0.31	2.3	2.9
*28	830630	801	50.63	15.2520	90.5180	1.02	1.57	0.24	1.4	11.0
*29	830630	825	45.43	15.2138	90.5472	0.22	1.32	0.12		
30	830701	701	45.05	15.3548	90.5343	9.40	1.51	0.19	1.3	1.3
31	830703	431	1.10	15.3115	90.6335	5.00	1.52	1.75	22.6	11.5
32	830703	444	27.10	15.3378	90.5180	4.50	1.16	16.98	41.9	76.4
33	830703	551	36.29	15.1503	90.5180	1.25	1.19	9.93	58.4	270.2
*34	830703	1245	49.88	15.2640	90.6335	5.00	1.57	0.65		
35	830703	2203	31.11	15.3072	90.5195	5.00	0.56	0.35	1.6	3.8
36	830705	948	34.51	15.3325	90.5860	2.50	0.85	0.21		
37	830706	1720	32.75	15.3893	90.2787	5.00	3.92	21.31	155.2	57.2
38	830706	2221	18.73	15.4277	90.5417	2.00	3.87	19.58	99.3	530.3
39	830707	729	43.13	15.3930	90.5415	2.50	1.63	2.12	15.5	40.4
40	830717	351	9.68	15.4255	90.5377	11.48	0.98	0.80	3.1	3.6
41	830721	2342	50.59	15.3377	90.6033	9.05	1.96	0.13	1.9	1.8
42	830723	53	40.23	15.3358	90.6308	7.43	1.08	0.03	0.3	0.2
43	830723	643	28.67	15.3162	90.5400	2.50	0.55	0.06		
*44	830724	1242	19.40	15.2138	90.5180	5.00	1.66	0.51		
45	830724	1247	3.44	15.2113	90.6098	1.37	1.54	2.95	66.4	486.7
46	830724	2100	52.86	15.3595	90.8453	14.62	1.86	0.50	8.8	11.6
47	830725	1913	50.27	15.3115	90.4520	14.80	2.10	1.37	16.1	9.1
48	830725	2027	28.58	15.1955	90.3183	11.26	1.91	0.42	6.0	15.0
49	830727	2330	33.99	15.3235	90.6240	9.79	2.26	0.16	1.4	1.4
*50	830730	621	22.60	15.2958	90.5372	10.80	1.51	0.43	11.7	9.9
*51	830731	1425	34.31	15.2692	90.6072	11.30	0.57	0.67	5.1	6.6
52	830806	1553	17.52	15.3442	90.5938	10.25	1.86	0.10	0.8	1.0
*53	830809	1647	42.80	15.2777	90.6335	5.00	1.33	0.54	4.0	4.9
54	830811	1733	23.14	15.3475	90.6023	13.92	2.14	0.57	3.2	3.5
55	830811	1734	57.74	15.3440	90.5882	14.14	2.58	0.42	2.3	2.7
*56	830813	156	19.46	15.2958	90.4767	5.00	1.56	0.42		
57	830813	1725	36.30	15.2120	90.2525	13.56	2.12	0.30	4.2	7.7
58	830814	546	37.81	15.3115	90.6335	2.50	1.97	9.87	47.8	49.5
59	830814	643	43.35	15.4593	90.4975	10.15	2.27	1.21		
60	830814	1324	17.61	15.3593	90.5112	0.31	0.98	11.53		

	*61	830816	1656	2.45	15.2198	90.5152	2.46	1.44	0.02		
	62	830816	2052	19.32	15.2963	90.9850	5.00	1.83	18.14	*****	*****
	*63	830817	251	51.53	15.2138	90.5180	5.00	1.23	0.17		
	64	830819	2132	40.11	15.1447	90.5793	2.50	1.09	0.19		
	65	830821	341	42.49	15.1750	90.4690	2.50	1.20	20.84	99.4	209.1
	66	830823	1538	2.50	15.3960	90.5748	10.39	3.06	1.02	5.2	7.9
	67	830824	244	7.05	15.3525	90.6862	13.28	2.73	0.48	3.7	3.4
	68	830825	49	47.82	15.3548	90.5248	12.32	2.15	0.42	2.3	3.1
	69	830825	404	25.75	15.3487	90.5803	11.40	2.16	0.48	2.6	4.0
	70	830825	2052	25.91	15.2138	90.5077	2.91	1.38	0.02		
	*71	830827	1129	26.66	15.3422	90.4800	5.92	0.73	0.08	1.8	2.5
	72	830828	1050	40.23	15.2375	90.4837	5.98	1.78	0.15	1.1	1.3
	73	830901	540	24.33	15.3403	90.4928	8.91	1.45	0.32	1.5	1.4
	74	830909	1300	23.68	15.3548	90.4163	12.20	1.27	0.91	3.6	5.5

* indicates water induced earthquakes located in the immediat vicinity of the reservoir

"SEISMICITY IN THE VICINITY OF THE PUEBLO VIEJO RESERVOIR"

PREPARED BY: DR. T. MATUMOTO

JUNE 23, 1983

- 1.- Station 7, located 11 Km. SSE of the dam site and situated along the southern shore line of the reservoir (Figure 1), was restored on May 30, 1983. With resumption of station 7, a number of events near station 7 was recorded by this station. From May 30 through June 21, 16 events with S-P time less than 2 seconds (16 Kms) were recorded, of which 5 earthquakes were with S-P time shorter than 1 second (8 - Km.) most of these events, however, were too small to be recorded by other stations and their location were left unknown. Some of the seismograms recorded by station 7 are shown in Fig. 2A and 2B.

- 2.- Five events located during this period were shown in Fig. 1. (by red symbols). As expected these events were distributed near the reservoir, presumably along unnamed fault (tentatively referred as Fault-A). As compared to pre-loading and early loading phase, which was characterized by devoid of activity in the immediate vicinity of the reservoir, the distribution of these events clearly shows the start of new active pattern. Increase of pore pressure probably affected to weaken the shear strength of the rocks near the reservoir and water induced earthquakes started to occur along a weak line (Fault A), in this area, none of the earthquakes that occurs near the reservoir was with magnitude greater than 2.0 and this activity is still considered to be of minor level. However, a rupture at the Fault A occurs along it's entire length, simultaneously an earthquakes with magnitude up to 4.5 can be expected.

